

EECE5698

Networked XR Systems

Lecture Outline for Today

- Open3D
- Depth Map Compression

Open3D

Abstraction Layers

Applications

Scene reconstruction,
color map
optimization ...



Open3D-ML

Models: RandLaNet,
KPConv,
PointTransformer, ...
Datasets: SemanticKITTI,
Toronto3D, S3DIS, ...

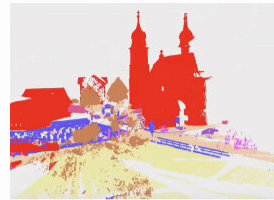

Visualization

Open3D viewer app,
Scriptable GUI,
Physically-based rendering,
Web visualizer,
TensorBoard integration.

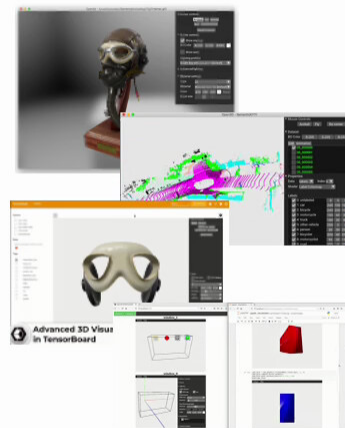

3D algorithms

Mesh processing, ICP
Odometry ...

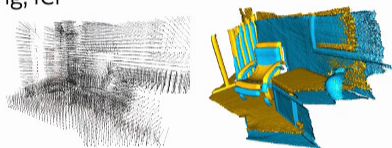

ML Ops

Continuous conv,
Sparse conv, NMS, ...

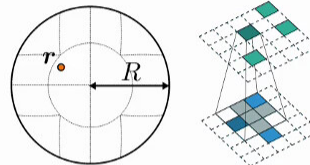

3D data structures

Point cloud, Mesh, Voxel, ...

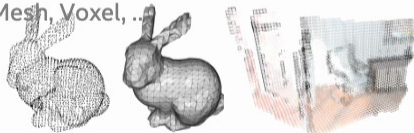

Sensors & File I/O

Intel RealSense, Azure Kinect, ...
*.pcd, *.ply, *.stl, ...



Compute core

Tensor, HashMap, NeighborSearch
Optimized for CPU/GPU

Devices

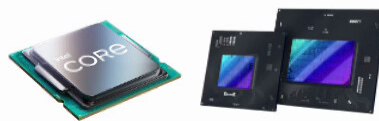

CPU

GPU

Device-agnostic computer cores

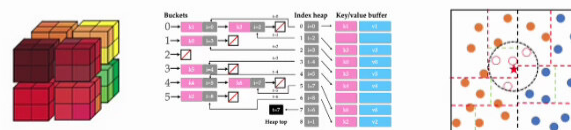

Tensor

HashMap

NeighborSearch

Open3D

- What will we use Open3D in this source for?
 - Loading and visualizing 3D models
 - Point clouds, Meshes
 - 3D Scene Reconstruction
 - Triangle Extraction
 - Texture Mapping
 - Mesh manipulation
 - Decimation
 - Normal estimation
 - Compression

Open3D Getting Started

- Python quick start

```
# Install
pip install open3d          # or
pip install open3d-cpu     # Smaller CPU only wheel on x86_64 Linux (v0.17+)

# Verify installation
python -c "import open3d as o3d; print(o3d.__version__)"
```

Open3D Getting Started

- C++ quick start

Checkout the following links to get started with Open3D C++ API

- Download Open3D binary package: [Release](#) or [latest development version](#)
- [Compiling Open3D from source](#)
- [Open3D C++ API](#)

To use Open3D in your C++ project, checkout the following examples

- [Find Pre-Installed Open3D Package in CMake](#)
- [Use Open3D as a CMake External Project](#)

Open3D Point Cloud Visualization

```
print("Load a ply point cloud, print it, and render it")
ply_point_cloud = o3d.data.PLYPointCloud()
pcd = o3d.io.read_point_cloud(ply_point_cloud.path)
print(pcd)
print(np.asarray(pcd.points))
o3d.visualization.draw_geometries([pcd],
                                   zoom=0.3412,
                                   front=[0.4257, -0.2125, -0.8795],
                                   lookat=[2.6172, 2.0475, 1.532],
                                   up=[-0.0694, -0.9768, 0.2024])
```

```
Load a ply point cloud, print it, and render it
PointCloud with 196133 points.
[[0.65234375 0.84686458 2.37890625]
 [0.65234375 0.83984375 2.38430572]
 [0.66737998 0.83984375 2.37890625]
 ...
 [2.00839925 2.39453125 1.88671875]
 [2.00390625 2.39488506 1.88671875]
 [2.00390625 2.39453125 1.88793314]]
```

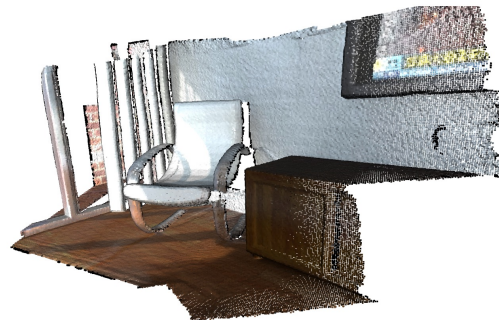

Open3D Point Cloud Visualization

```
print("Downsample the point cloud with a voxel of 0.05")
downpcd = pcd.voxel_down_sample(voxel_size=0.05)
o3d.visualization.draw_geometries([downpcd],
                                   zoom=0.3412,
                                   front=[0.4257, -0.2125, -0.8795],
                                   lookat=[2.6172, 2.0475, 1.532],
                                   up=[-0.0694, -0.9768, 0.2024])
```

Downsample the point cloud with a voxel of 0.05

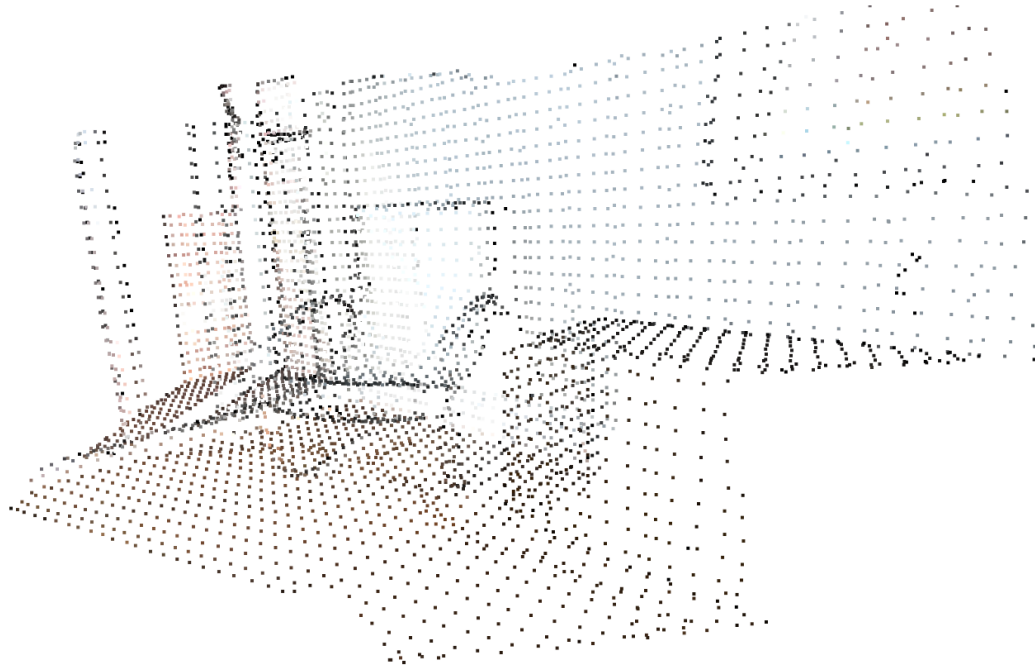

Down sampling

Open3D Mesh Visualization

```
print("Testing mesh in Open3D...")
armadillo_mesh = o3d.data.ArmadilloMesh()
mesh = o3d.io.read_triangle_mesh(armadillo_mesh.path)

knot_mesh = o3d.data.KnotMesh()
mesh = o3d.io.read_triangle_mesh(knot_mesh.path)
print(mesh)
print('Vertices:')
print(np.asarray(mesh.vertices))
print('Triangles:')
print(np.asarray(mesh.triangles))
```

```
Testing mesh in Open3D...
[Open3D INFO] Downloading https://github.com/isl-org/open3d_downloads/releases/download/
[Open3D INFO] Downloaded to /home/runner/open3d_data/download/KnotMesh/KnotMesh.ply
TriangleMesh with 1440 points and 2880 triangles.
Vertices:
[[ 4.51268387  28.68865967 -76.55680847]
 [ 7.63622284  35.52046967 -69.78063965]
 [ 6.21986008  44.22465134 -64.82303619]
 ...
 [-22.12651634  31.28466606 -87.37570953]
 [-13.91188431  25.4865818  -86.25827026]
 [-5.27768707  23.36245346 -81.43279266]]
Triangles:
[[ 0  12  13]
 [ 0  13  1]
 [ 1  13  14]
 ...
 [1438  11 1439]
 [1439  11  0]
 [1439  0 1428]]
```

Open3D Mesh Visualization

```
print("Try to render a mesh with normals (exist: " +  
      str(mesh.has_vertex_normals()) + ") and colors (exist: " +  
      str(mesh.has_vertex_colors()) + ")")  
o3d.visualization.draw_geometries([mesh])  
print("A mesh with no normals and no colors does not look good.")
```

Try to render a mesh with normals (exist: False) and colors (exist: False)

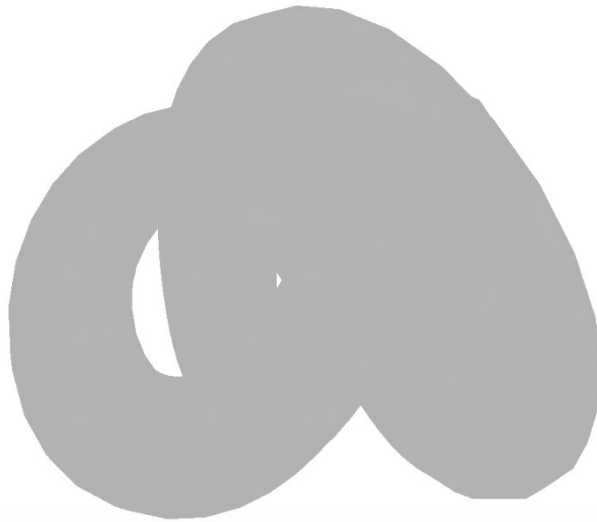

Open3D Mesh Visualization

```
print("Computing normal and rendering it.")
mesh.compute_vertex_normals()
print(np.asarray(mesh.triangle_normals))
o3d.visualization.draw_geometries([mesh])
```

```
Computing normal and rendering it.
[[ 0.79164373 -0.53951444  0.28674793]
 [ 0.8319824  -0.53303008  0.15389681]
 [ 0.83488162 -0.09250101  0.54260136]
 ...
 [ 0.16269924 -0.76215917 -0.6266118 ]
 [ 0.52755226 -0.83707495 -0.14489352]
 [ 0.56778973 -0.76467734 -0.30476777]]
```

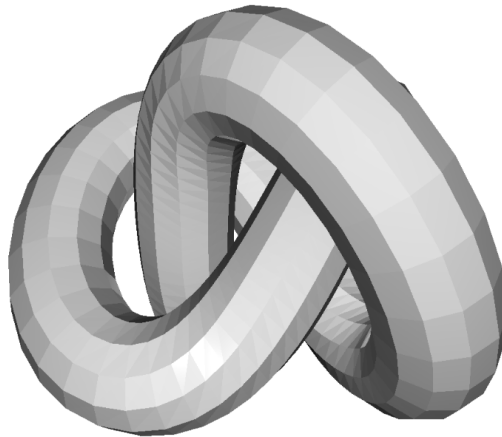

With Normals

Open3D Mesh Visualization

```
bunny = o3d.data.BunnyMesh()  
mesh = o3d.io.read_triangle_mesh(bunny.path)  
mesh.compute_vertex_normals()  
  
o3d.visualization.draw_geometries([mesh])  
pcd = mesh.sample_points_uniformly(number_of_points=500)  
o3d.visualization.draw_geometries([pcd])
```

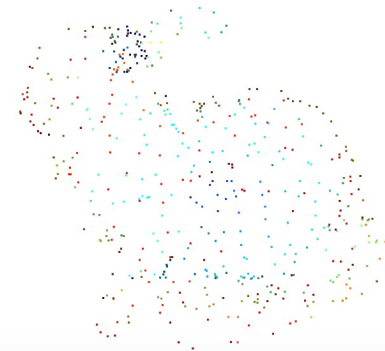
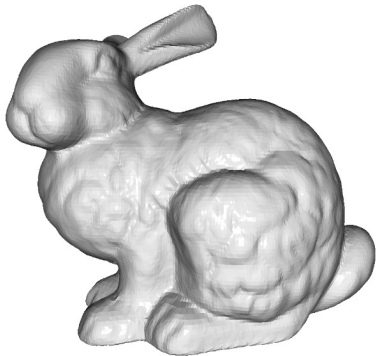

Sampling Point Clouds from Mesh

Open3D Mesh Visualization

```
voxel_size = max(mesh_in.get_max_bound() - mesh_in.get_min_bound()) / 32
print(f'voxel_size = {voxel_size:e}')
mesh_smp = mesh_in.simplify_vertex_clustering(
    voxel_size=voxel_size,
    contraction=o3d.geometry.SimplificationContraction.Average)
print(
    f'Simplified mesh has {len(mesh_smp.vertices)} vertices and {len(mesh_smp.triangles)}
')
o3d.visualization.draw_geometries([mesh_smp])
```

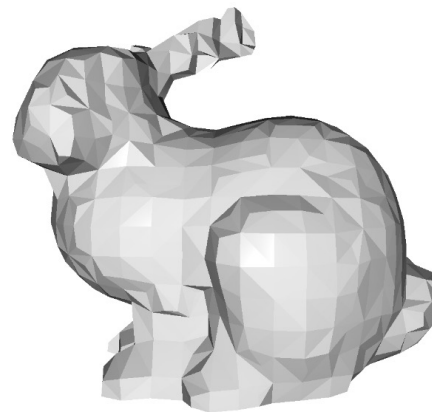
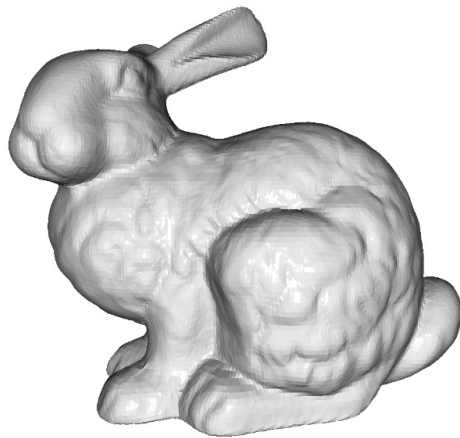

Mesh Simplification – Vertex clustering

Open3D Mesh Visualization

```
mesh_smp = mesh_in.simplify_quadric_decimation(target_number_of_triangles=6500)
print(
    f'Simplified mesh has {len(mesh_smp.vertices)} vertices and {len(mesh_smp.triangles)}
)
o3d.visualization.draw_geometries([mesh_smp])

mesh_smp = mesh_in.simplify_quadric_decimation(target_number_of_triangles=1700)
print(
    f'Simplified mesh has {len(mesh_smp.vertices)} vertices and {len(mesh_smp.triangles)}
)
o3d.visualization.draw_geometries([mesh_smp])
```

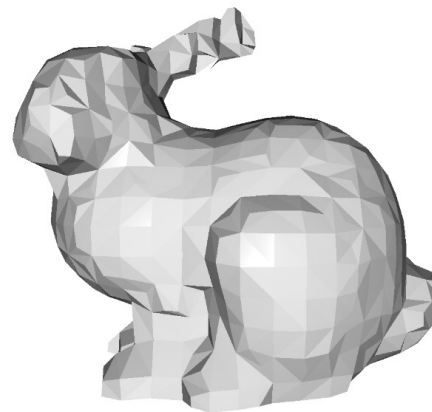
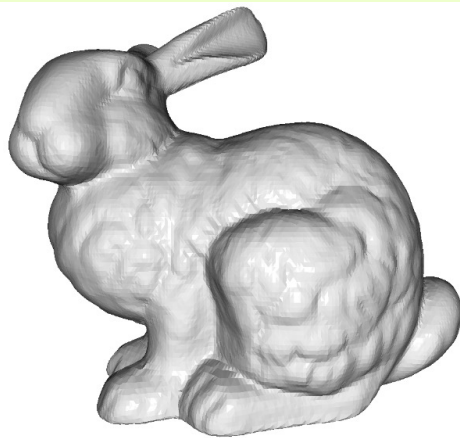

Mesh Simplification – Decimation

Open3D Mesh Reconstruction

```
print('run Poisson surface reconstruction')
with o3d.utility.VerboesityContextManager(
    o3d.utility.VerboesityLevel.Debug) as cm:
    mesh, densities = o3d.geometry.TriangleMesh.create_from_point_cloud_poisson(
        pcd, depth=9)
print(mesh)
o3d.visualization.draw_geometries([mesh],
                                   zoom=0.664,
                                   front=[-0.4761, -0.4698, -0.7434],
                                   lookat=[1.8900, 3.2596, 0.9284],
                                   up=[0.2304, -0.8825, 0.4101])
```

Read a point cloud or depth before this function

Open3D Load and Save Viewpoints

```
def save_view_point(pcd, filename):  
    vis = o3d.visualization.Visualizer()  
    vis.create_window()  
    vis.add_geometry(pcd)  
    vis.run() # user changes the view and press "q" to terminate  
    param = vis.get_view_control().convert_to_pinhole_camera_parameters()  
    o3d.io.write_pinhole_camera_parameters(filename, param)  
    vis.destroy_window()
```

```
def load_view_point(pcd, filename):  
    vis = o3d.visualization.Visualizer()  
    vis.create_window()  
    ctr = vis.get_view_control()  
    param = o3d.io.read_pinhole_camera_parameters(filename)|  
    vis.add_geometry(pcd)  
    ctr.convert_from_pinhole_camera_parameters(param)  
    vis.run()  
    vis.destroy_window()
```

Open3D UV Maps

What is a UV Map ?

[Ref: [Wikipedia](#)] UV mapping is the 3D modeling process of projecting a 2D image to a 3D model's surface for texture mapping. The letters "U" and "V" denote the axes of the 2D texture because "X", "Y", and "Z" are already used to denote the axes of the 3D object in model space. UV texturing permits polygons that make up a 3D object to be painted with color (and other surface attributes) from an ordinary image. The image is called a UV texture map.

How to add custom UV maps ? <#>

- UV Map coordinates (U, V) are stored as `std::vector<Eigen::Vector2d>` of length `3 x number of triangles`. So, there is a set of 3 (U, V) coordinates for each triangle, each associated with it's vertices.
- One may assume the UV map, maps a texture image of height and width of length 1.0 to the geometry. So, the range of U and V is from 0.0 to 1.0 (both inclusive).

Open3D UV Maps

```
import open3d as o3d
import open3d.visualization.rendering as rendering

material = rendering.MaterialRecord()
material.shader = 'defaultUnlit'
material.albedo_img = o3d.io.read_image('/Users/renes/Downloads/uv1.png')
```

Example Texture Map

A1	A2	A3	A4	A5	A6	A7	A8
B1	B2	B3	B4	B5	B6	B7	B8
C1	C2	C3	C4	C5	C6	C7	C8
D1	D2	D3	D4	D5	D6	D7	D8
E1	E2	E3	E4	E5	E6	E7	E8
F1	F2	F3	F4	F5	F6	F7	F8
G1	G2	G3	G4	G5	G6	G7	G8
H1	H2	H3	H4	H5	H6	H7	H8

Open3D UV Maps

Box (map uv to each face = false)

```
box = o3d.geometry.TriangleMesh.create_box(create_uv_map=True)  
o3d.visualization.draw({'name': 'box', 'geometry': box, 'material': material})
```

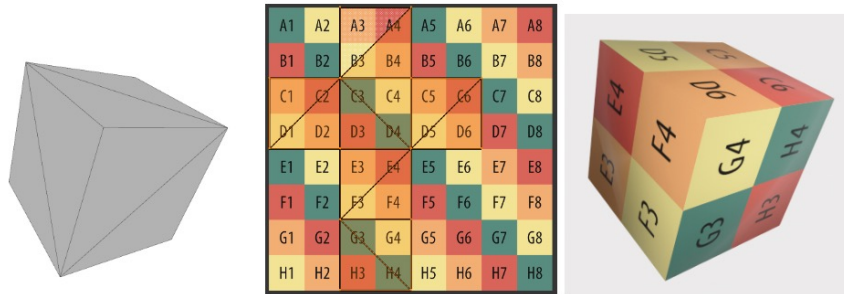

Box (map uv to each face = true)

```
box = o3d.geometry.TriangleMesh.create_box(create_uv_map=True, map_texture_to_each_face=True)  
o3d.visualization.draw({'name': 'box', 'geometry': box, 'material': material})
```

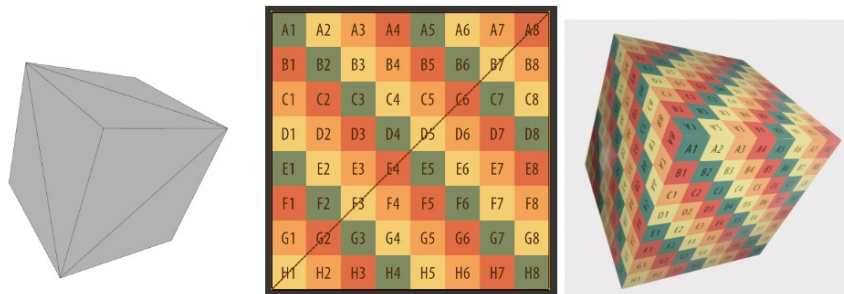

Open3D Depth Map Viewer

```
print("Read Redwood dataset")
redwood_rgbd = o3d.data.SampleRedwoodRGBDImages()
color_raw = o3d.io.read_image(redwood_rgbd.color_paths[0])
depth_raw = o3d.io.read_image(redwood_rgbd.depth_paths[0])
rgb_image = o3d.geometry.RGBDImage.create_from_color_and_depth(
    color_raw, depth_raw)
print(rgb_image)
```

```
plt.subplot(1, 2, 1)
plt.title('Redwood grayscale image')
plt.imshow(rgb_image.color)
plt.subplot(1, 2, 2)
plt.title('Redwood depth image')
plt.imshow(rgb_image.depth)
plt.show()
```

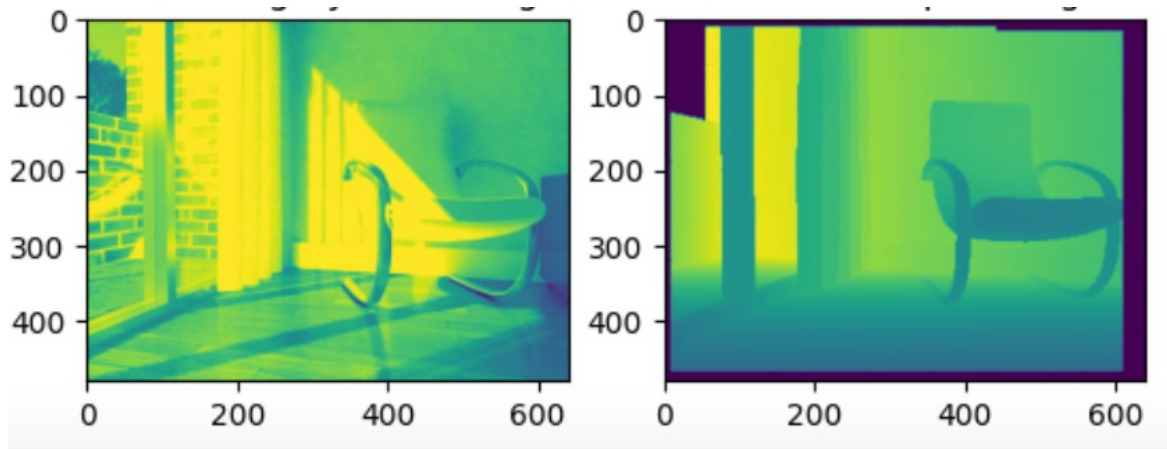

Depth Map Compression

- Why do we need depth compression?
 - For storage
 - For streaming over a network under lower bandwidths
 - For 3D scene reconstruction on client devices

Depth Map Compression

- How to compress depth?
 - Can we use similar ideas that we discussed in case of 2D video codecs?
 - Frame prediction
 - Transform coding & quantization
 - Entropy coding

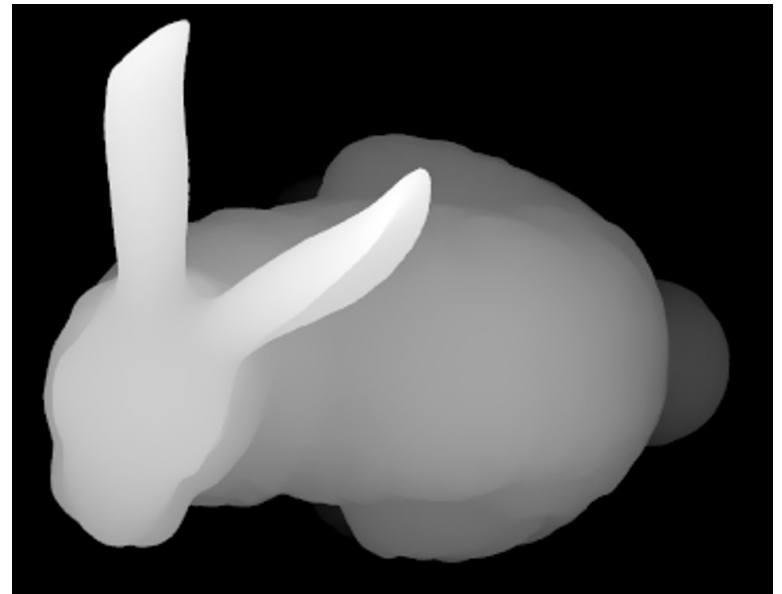

Lecture Outline for Today

- Open3D
- Depth Map Compression

Depth Map Compression

- Why not just adopt standard video codecs?
 - They have been engineered for decades
 - Probably no need to reinvent similar algorithms if we can directly input the depth videos to color video codecs

Adopting Standard Video Codecs

- Challenge

- Compression schemes for standard videos are highly tuned for color videos
- Considering human perception, e.g., by spending fewer bits on color than luminance information, and so forth.
- These insights do not apply to depth compression.

Adopting Standard Video Codecs

- Challenge
 - Bit-depth and channel inconsistency
 - Depth videos are single channeled
 - Bit-depth of depth videos is larger than color videos in general
- Example: 8-bit videos can only store coarse-grained depth or short range (trade-off), so typically you need 16-bit or 24-bit or 32-bit-detphs for depth videos

Adopting Standard Video Codecs

- Can we convert the single channel large bit-depths to three channel small bit-depth?

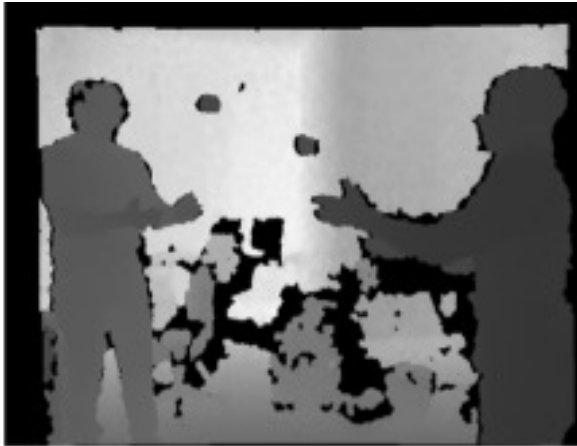

Adopting Standard Video Codecs

- Example: How do we pack a single 16 bit-depth depth map into a three channel 8 bit-depth depth map?
- Bit Multiplexing Method
 - Take a chunk of bits from 16 bits, insert them in each in 8-bit channel
 - E.g., first 6 MSB of 16-bits into first 6 MSB of first channel, subsequent 5 bits into first 5 MSB of second channel, last 5 bits into first 5 MSB of third channel
 - Pad with zeros for the remaining bits

Adopting Standard Video Codecs

- Example: How do we pack a single 16 bit-depth depth map into a three channel 8 bit-depth depth map?
- Bit Multiplexing Method
 - Take a chunk of bits from 16 bits, insert them in each in 8-bit channel
 - Problems?
 - Loss in MSBs can cause large depth discontinuities

Adopting Standard Video Codecs

- Example: How do we pack a single 16 bit-depth depth map into a three channel 8 bit-depth depth map?
- Interleaved Bit Multiplexing
 - Slightly better solution

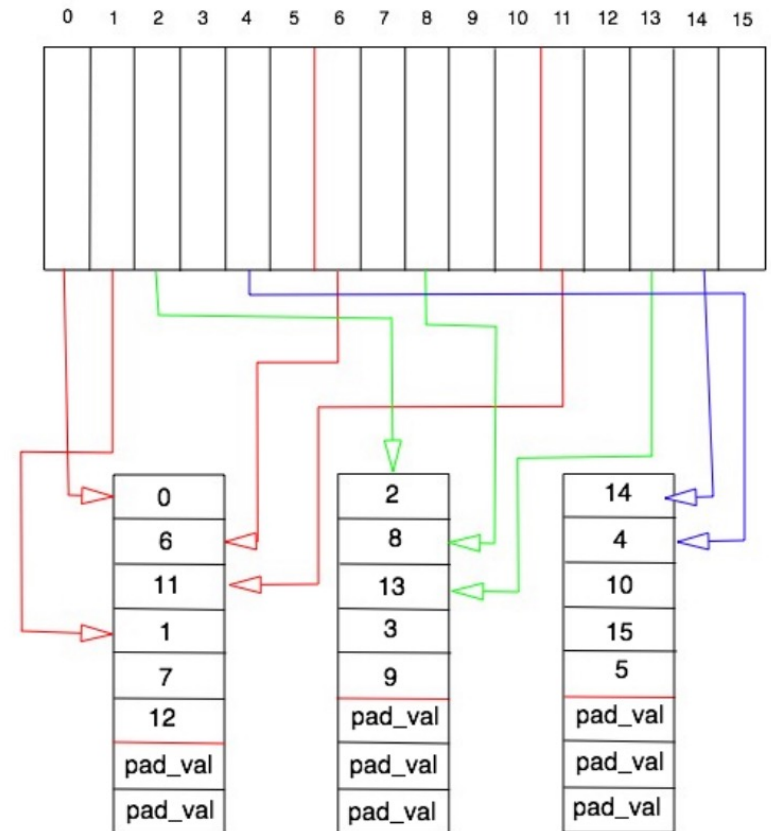

Adapting Standard Video Codecs

- General Limitations
 - Lossy
- Lossless entropy coding
 - Fast Lossless Depth Image Compression, ISS'17
 - Skips frame prediction, transform and quantization to avoid depth discontinuities
 - Applies entropy coding
 - But only for images, not for video
 - Temporal RVL: A Depth Stream Compression Method, IEEE VR'20
 - For videos; computes deltas across frames

Lecture Summary

- Open3D
- Depth Map Compression